

CM-1000 Series

Key Switch

INSTALLATION INSTRUCTIONS



PACKAGE CONTENTS	
(1) Heavy duty diecast surface box	
(1) Heavy duty 1/4" thick aluminum faceplate	
(2) Tamper proof screws and driver	
(1) Color coded 18 AWG soldered leads	
(1) Weatherproof gasket	
(1) Lock ring	

Note: Mortise Cylinder Sold Separately

1. GENERAL DESCRIPTION

Camden key switches are designed to work with most 1", 1 1/8" or 1 1/4" mortise cylinders, and with different types of cams.

One or two switches may be installed, either momentary and/or maintained (alternating on/off).

2. SPECIFICATIONS

Input Voltage	12-24V AC/DC
Contact Rating	6A @ 30VDC (Standard), 15A @ 30VDC (Optional)
Switch Life	100,000 cycles
Temp Range	32°F - 85°F (0°C to +85°C)
Standard Finish	Brushed aluminum
Dimension	2 3/4" W x 4 1/2" H x 2" D (70mm x 114mm x 51mm)

3. INSTALLATION

1. The switch (es) provided may be mounted in either the left or the right hole on the back of the faceplate. Thread the octagonal nut (spacer ring) on to the bushing (stem) of the switch before placing the switch in the hole.
2. Insert the switch up through the bottom of the desired hole. Secure the switch in place by screwing the round threaded washer onto the top of the switch.
3. Fit the mortise cylinder through the front of the face plate being sure to align the grooves on the sides of the cylinder with the corresponding "retainers" on the back of the face plate.

4. Push firmly on the cylinder, until it snaps into place, lying flush in the front of the face plate (aluminum models only). Note that some cylinders may appear not to fit in the face plate. If the grooves on the side of the cylinder are irregular and do not align with the retainers on the back of the faceplate, use a metal file to file down the retainers slightly.

Note - do not file the retainers off completely as they prevent the cylinder from spinning in the face plate.

5. Thread the brass cylinder lock ring onto the back of the cylinder, and tighten in place.
6. Turn the key in the cylinder, and ensure the cam hits the top of the switch squarely in the center. Adjust the switch in the slotted hole until the cam hits in the center. It does not affect operation of the cam if the cylinder rests against the switch, so long as the switch is not fully depressed until activated by a turn of the key. If the cam does not depress the switch, or blocks the switch from resetting, raise or lower the octagonal nut located under the switch, as needed. Extra spacers are provided and may be used as required.
7. Once the electrical connections are completed (see fig 2), attach the faceplate assembly to the surface box using the supplied tamperproof or stainless steel Phillips screws. For outdoor use, place the rubber weather proofing gasket behind the face plate prior to securing to the surface box.

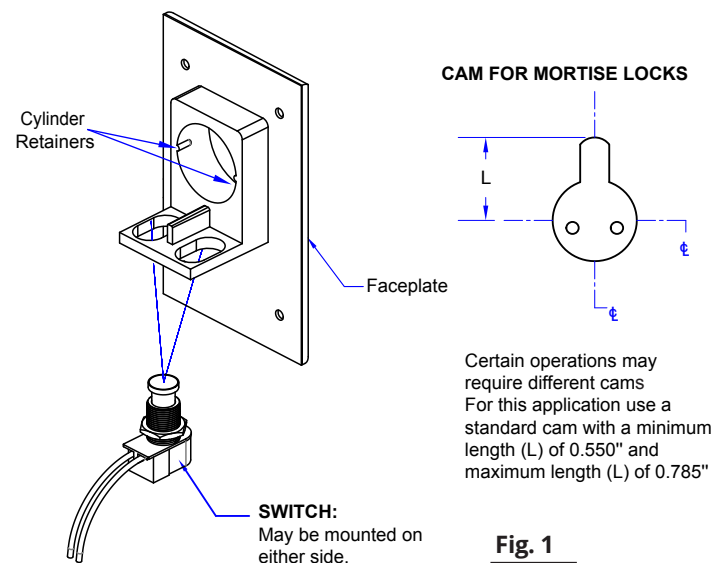

Fig. 1

CM-1000 SERIES KEY SWITCH

INSTALLATION INSTRUCTIONS

4. WIRING

WIRING LAYOUT & COLOR CODING

SWITCH TYPE	1 SPST MOMENTARY N.O. or N.C.	2 SPST MAINTAINED N.O. or N.C.	3 SPDT MOMENTARY	4 SPDT MAINTAINED	5 DPDT MOMENTARY	6 DPDT MAINTAINED
COMMON	BLACK	BLACK	GREY	GREY	GREY (X2)	GREY (X2)
NORMALLY OPEN	BLACK	BLACK	BLUE	ORANGE	BLUE (X2)	ORANGE (X2)
NORMALLY CLOSED	BLACK	BLACK	ORANGE	ORANGE	ORANGE (X2)	ORANGE (X2)

SPST

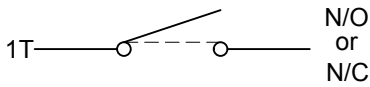

Momentary: When the switch is pressed the current pole will change to the opposite state until released.

Maintained: When the switch is pressed it will provide the opposite pole until the button is pressed again

SPDT

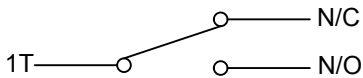

Momentary: When the switch is pressed it will provide a change of state on the N.O. & N.C. poles until released

Maintained: When the switch is pressed it will provide a change of state on the N.O. & N.C. poles until button pressed again

DPDT

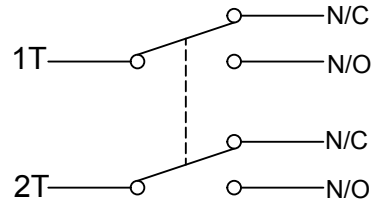

Momentary: When the switch is pressed it will provide a change of state on both of the N.O. & N.C. poles until released

Maintained: When the switch is pressed it will provide a change of state on both of the N.O. & N.C. poles until pressed again

Fig. 2

5. OPTIONAL WIRING

Key Switches may be ordered with optional LED's. These drawings show the various wiring configurations of the LED's.

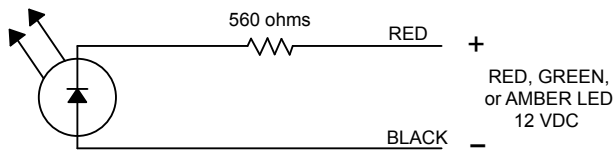

NOTE:
These LEDs are designed for DC Voltage only.

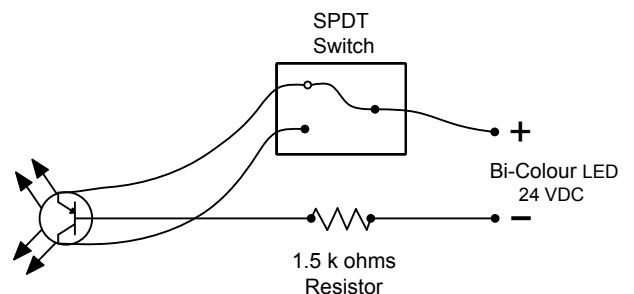
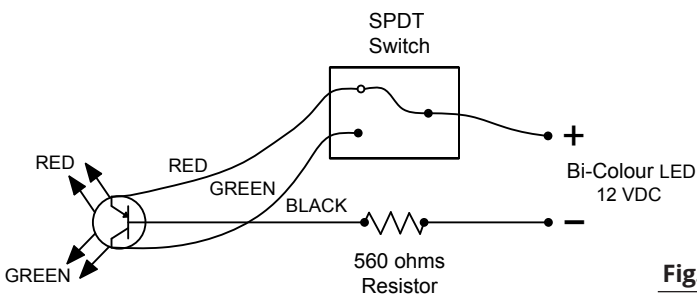
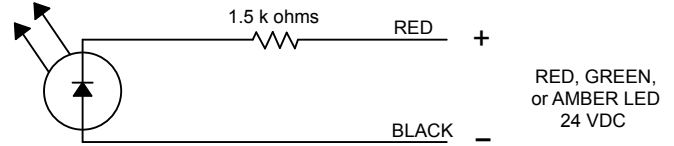
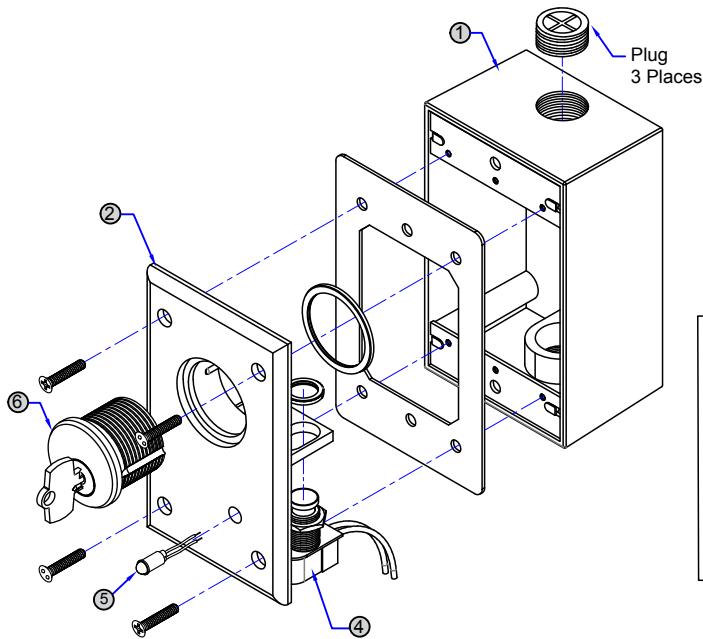
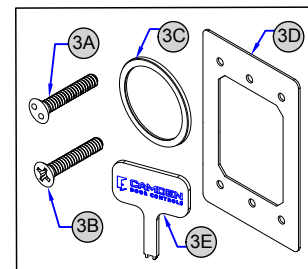

Fig. 3

6. ORDERING INFORMATION FOR REPLACEMENT PARTS



NOTE:
CM-1000 Series with option to install one or two switches (SPST, SPDT or DPDT) either momentary and/or maintained (Refer to switch options table)



ITEM NUMBER	PART NUMBER	DESCRIPTION
1	60-42C032	SINGLE GANG ALUMINUM BOX 2 7/8"W X 4 5/8"H X 2"D (72MM X 117MM X 51MM)
2	60-41A000	DIE-CAST ALUMINUM SINGLE GANG FACE PLATE FOR SURFACE MOUNT KEY SWITCHES

PARTS KIT

3	60-34B030	(A) 6-32 X 3/4 SNAKE EYE TAMPER PROOF SCREWS, (B) 6-32 X 3/4 FLAT HEAD PHILLIPS ZINC PLATED SCREWS, (C) CYLINDER LOCK RING, (D) NEOPRENE GASKET FOR SINGLE GANG SWITCHES, (E) KEY FOR TAMPER PROOF SCREWS (SNAKE EYE)
---	-----------	---

CONTACT SWITCH OPTIONS

ITEM NUMBER	MODEL NUMBER	QTY	PART NUMBER	DESCRIPTION
4	CM-1000	1	60-68D046	SPST MOMENTARY CONTACT SWITCH, N/O 6A @125V AC, 3A@ 30V DC
	CM-1005	1	60-68D048	SPST MOMENTARY CONTACT SWITCH, N/C 6A @125V AC, 3A@ 30V DC
	CM-1010	1	60-68D049	SPST MAINTAINED CONTACT SWITCH, ON/OFF 6A @125V AC, 3A@ 30V DC
	CM-1020	1	60-68D052	SPDT MOMENTARY CONTACT SWITCH, 6A @125V AC, 3A@ 30V DC
	CM-1030	1	60-68D054	SPDT MAINTAINED CONTACT SWITCH, 6A @125V AC, 3A@ 30V DC
	CM-1050	2	60-68D052	SPDT MOMENTARY CONTACT SWITCH, 6A @125V AC, 3A@ 30V DC
	CM-1060	2	60-68D054	SPDT MAINTAINED CONTACT SWITCH, 6A @125V AC, 3A@ 30V DC
	CM-1070	1	60-68D052	SPDT MOMENTARY CONTACT SWITCH, 6A @125V AC, 3A@ 30V DC
			60-68D054	SPDT MAINTAINED CONTACT SWITCH, 6A @125V AC, 3A@ 30V DC
	CM-1080	1	60-68D053	DPDT MOMENTARY CONTACT SWITCH, 6A @125V AC, 3A@ 30V DC
	CM-1082	2	60-68D053	DPDT MOMENTARY CONTACT SWITCH, 6A @125V AC, 3A@ 30V DC
	CM-1090	1	60-68D055	DPDT MAINTAINED CONTACT SWITCH, 6A @125V AC, 3A@ 30V DC
CM-1092	2	60-68D055	DPDT MAINTAINED CONTACT SWITCH, 6A @125V AC, 3A@ 30V DC	

HEAVY DUTY CONTACT SWITCH OPTIONS		
ITEM NUMBER	PART NUMBER	DESCRIPTION
4	60-68D047	SPST MOMENTARY CONTACT SWITCH, HEAVY DUTY, 15A@ 30V DC
	60-68D050	SPST MAINTAINED CONTACT SWITCH, HEAVY DUTY, 15A@ 30V DC

ITEM NUMBER	SINGLE LED OPTIONS				DOUBLE LED OPTIONS			
	MODEL NUMBER	QTY	PART NUMBER	DESCRIPTION	MODEL NUMBER	QTY	PART NUMBER	DESCRIPTION
5	CM-XXXX-7012	1	60-73C008	RED 12V LED	CM-XXXX-70122	2	60-73C008	RED 12V LEDS
	CM-XXXX-7024	1	60-73C010	RED 24V LED	CM-XXXX-70242	2	60-73C010	RED 24V LEDS
	CM-XXXX-7112	1	60-73C009	GREEN 12V LED	CM-XXXX-71122	2	60-73C009	GREEN 12V LEDS
	CM-XXXX-7124	1	60-73C011	GREEN 24V LED	CM-XXXX-71242	2	60-73C011	GREEN 24V LEDS
	CM-XXXX-7212	1	60-73C009	GREEN 12V LED	CM-XXXX-72122	2	60-73C009	GREEN 12V LEDS
		1	60-73C008	RED 12V LED		2	60-73C008	RED 12V LEDS
	CM-XXXX-7224	1	60-73C011	GREEN 24V LED	CM-XXXX-72242	2	60-73C011	GREEN 24V LEDS
		1	60-73C010	RED 24V LED		2	60-73C010	RED 24V LEDS
	CM-XXXX-7412	1	60-73C014	AMBER 12V LED	CM-XXXX-74122	2	60-73C014	AMBER 12V LEDS
	CM-XXXX-7424	1	60-73C012	AMBER 24V LED	CM-XXXX-74242	2	60-73C012	AMBER 24V LEDS
	CM-XXXX-7612	1	60-66B001-12	BI-COLOR 12V (3 WIRE) LED	CM-XXXX-76122	2	60-66B001-12	BI-COLOR 12V (3 WIRE) LED
	CM-XXXX-7624	1	60-66B001-24	BI-COLOR 24V (3 WIRE) LED	CM-XXXX-76242	2	60-66B001-24	BI-COLOR 24V (3 WIRE) LED

OPTIONAL MORTISE CYLINDERS		
ITEM NUMBER	PART NUMBER	DESCRIPTION
6	CM-1000/60KD	MORTISE CYLINDER 1 1/8", KEYED DIFFERENT (SOLD SEPARATELY)
	CM-1000/60KA	MORTISE CYLINDER 1 1/8", KEYED ALIKE (SOLD SEPARATELY)
	CM-307	MORTISE CYLINDER HOUSING FOR BEST™ STYLE IC CORE (SOLD SEPARATELY)
	CM-308	BEST™ STYLE IC CORE, KEYED DIFFERENT (SOLD SEPARATELY)