

# SpotScan

## Active-Infrared-Presence Detector

### Operating instructions

### English

#### 1 Safety instructions



The unit may only be operated at protective low voltage in conjunction with safe electrical isolation. The unit may only be repaired by the supplier. Avoid contact with electronic and optical components. Protect the sensor against rain and snow.

#### 2 Product variants

- SpotScan** Version with relay output
- SpotScan P** Version with electronic output PNP

#### 3 Product overview

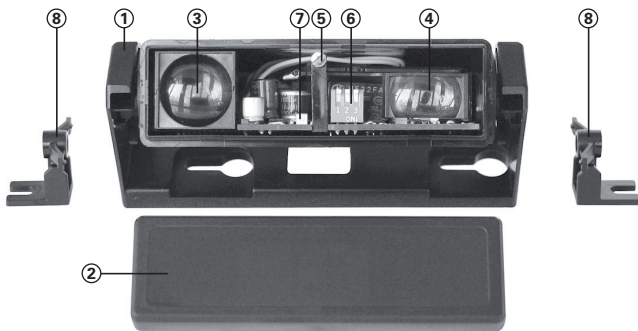

- ① Swivel bracket
- ② Front cover with optics window
- ③ Transmitter lens
- ④ Receiver lens
- ⑤ Scanning range adjustment screw
- ⑥ DIP switches 1-3
- ⑦ LED display
- ⑧ Bracket set (in lieu of swivel bracket)

#### 4 Installation



Max. mounting height of 3.2 m (10.5 ft) should not be exceeded

Swivel bracket with ratchet disc  
(e.g. surface-type installation)

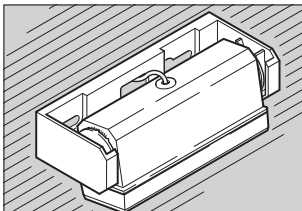

Mounting bracket set  
(e.g. integration)

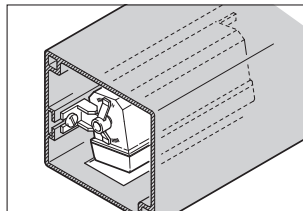

Recessed mounting frame  
(Special equipment for integration)

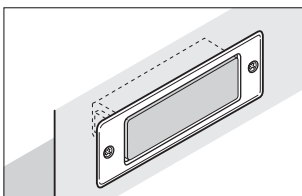

Further installation accessories  
available on request:

- Protective cover
- Flush-type inlet box
- Surface-type box
- Flush-type set
- Flush-type cover

#### 5 Electrical connections

##### SpotScan connection diagram

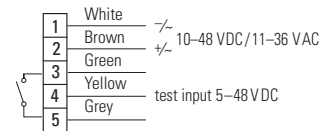

##### SpotScan P connection diagram

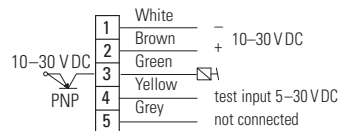

##### Instructions for testing input:

- Only use the test input when the sensor is operated in the stationary mode (background analysis). See also Sect. 6.2.
- Testing is only possible with DC power supply.

#### 6 Settings



- DIP-Switch 1
- DIP-Switch 2
- DIP-Switch 3

##### 6.1 Frequency switching (DIP switch 1)

	OFF	Frequency 1
	ON	Frequency 2

Sensors with small installation clearance (< 50 mm / 2") can interact. To avoid this, a choice can be made between two different transmission frequencies (1 and 2). These should be set alternately.

##### 6.2 Operating mode (DIP switch 2)

	OFF	Stationary mode (background analysis)
	ON	Mobile mode (background suppression)

Choice between **stationary** and **mobile** operating mode:  
Mobile = background is ignored (background suppression).  
Stationary = background may not change (background analysis). Only fixed mounting possible.  
The testing function only works with the stationary operating mode.

##### 6.3 Output switching mode (DIP-switch 3)

	OFF	<b>Active</b> when stationary mode <b>Passive</b> when mobile mode
	ON	<b>Passive</b> when stationary mode <b>Active</b> when mobile mode

**Active** or **passive** switching mode. Definitions:  
Active = output is activated, when an object is detected in the detection range  
Passive = output is activated when no object is detected in the detection range  
**Important:** Active/passive is the opposite way around with stationary and mobile operating mode. See also Sect. 6.2 for the operating mode.

#### 7 Adjusting the scanning range

The scanning range is adjusted using a screwdriver at the adjustment screw.

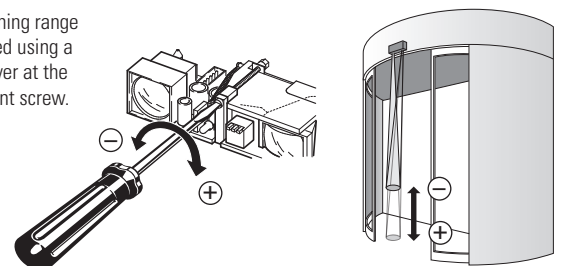

## 8 Setting the switching point

- Turn the adjusting screw clockwise to the end stop (= maximum scanning range)
- Turn the adjusting screw anti-clockwise until the state of the LED display changes. As soon as the LED state changes, the switching point is set directly over the floor.
  - When making adjustments do not reach into the detection beam with the hand, any part of the body or with the screwdriver, etc. (hold the screwdriver slightly diagonally upright).
- To avoid false detection by subsequent changes of the background, set the switching point back to approx. 250 mm (10") above the floor for indoor installations and approx. 350mm (14") for outdoor installations
  - To do so, turn the adjusting screw a little further in the anti-clockwise direction.
  - The switching point can be easily located from below by hand or using a sheet of paper: The LED display changes its state, as soon as the hand or the piece of paper reaches the switching point.
- Close the cover and check the settings once more. If necessary, make further adjustments.

## 9 Switching state

The following diagrams show the switching state of the output and of the LED display, when an object is captured in the detecting range. There will be differences in the active and passive switching mode of the output. The definitions in Sect. 6.3 should be observed!

### 9.1 Stationary operating mode (DIP switch 2 = OFF)

Active switching mode		Passive switching mode	
Output	LED display	Output	LED display
OFF	○	ON	☀
ON	☀	OFF	○
OFF	○	ON	☀

\*\* approx. 250mm (10") for indoor installations  
approx. 350mm (14") for outdoor installations

### 9.2 Mobile operating mode (DIP switch 2 = ON)

Active switching mode		Passive switching mode	
Output	LED display	Output	LED display
OFF	○	ON	☀
ON	☀	OFF	○
OFF	○	ON	☀

\*\* approx. 250mm (10") for indoor installations  
approx. 350mm (14") for outdoor installations

## 10 Testing function

The correct functioning of the sensor is checked using the testing function.

Whilst the testing is in operation (the test input is subjected to electrical tension), the transmitter

Switching mode	Output	LED display
active	ON	○
passive	OFF	☀

is switched off. This simulates an object in the detection area (detection) and causes the switching state of the output to change. **Important: Testing is only possible in the stationary operating mode. See sect. 5 for the allowed voltage levels and further instructions on the use of the testing function.** The table shows the switching state of the output and the LED display when the test input is activated.

## 11 Trouble shooting

- Check operating voltage and electrical connections → Sect. 5
- Interaction influence of sensors → Sect. 6.1
- Maximum mounting height (scanning range) of 3.2 m (10.5 ft) exceeded?
- Is the floor recognized as an object? Is the switching point correctly adjusted? → Sect. 8 and 9

## 12 Technical data

	SpotScan	SpotScan P	Remarks
Scanning range	max. 3200 mm (10.5 ft)		= max. mounting height
Scanning range adjustment	1000–3200 mm (3.3–10.5 ft) with mechanical adjusting screw		triangulation principle
Detecting range	100 – approx. 3000 mm (4"–118") 500 – approx. 3000 mm (19.7"–118")		stationary mode mobile mode
Temperature dependence of detecting range	at +60°C (140°F): +10% / at –20°C (–4°F): –10%		linear deviation from 20°C (68°F) with ref. to the switching point set
Black/white difference	< 400 mm (15.75")		at 2000 mm (6.5 ft) scanning range
Detection field	approx. 50 x 50 mm (2" x 2")		light beam cross-section at 2000 mm (6.5 ft) scanning range
Type of light	pulsed, intermittent IRED		2 frequencies selectable with DIP switch
Operating voltage	10-48 V DC or 11-36 V AC	10 – 30 V DC	
Residual ripple	max. 10%		with DC operation
Current / power consumption	max. 100 mA / approx. 3 W / 3 VA		
Operating mode	stationary or mobile		selectable with DIP switch
Output switching mode	active or passive		selectable with DIP switch
Signal output	relay, 1 contact normally open max. switching voltage 48 V AC/V DC max. switching current 0.5A AC / 1 A DC max switching capacity 55 VA / 24 W	1 PNP transistor 0.2 A / 30 V DC open collector short-circuit proof, reversed polarity protection	to SpotScan: relay contact electrically isolated nominal current (ohmic load) 1 A / 24 V DC for ind./cap. load, provide spark quenching ohmic load
Response time	approx. 35 ms / approx. 100 ms	approx. 25 ms / approx. 80 ms	with detection / with test signal
Drop-out time	max. 20 ms / max. 20 ms	max. 10 ms / max. 10 ms	with stationary mode / with mobile mode
Test input	5–48 V DC	5–30 V DC	only with DC operating voltage and stationary mode
Function display	LED red		illuminates when output is ON
Type of connection	cable 5 m (16.4 ft) / 5 x 0.25 mm <sup>2</sup> (AWG 24)		with plug-in connector, circuit board side
Protection class	IP52		with protective cover accessory IP 65
Housing material, colour	ABS black / Lexan		housing / optics window in front cover
Dimensions	sensor only: 102 x 45 x 32 mm (4.01" x 1.77" x 1.97") incl. swivel bracket: 123 x 45 x 50 mm (4.84" x 1.77" x 1.97") incl. bracket set: 140 x 45 x 34 mm (5.51" x 1.77" x 1.34")		L x W x H
Operating temperature range	–20°C to +60°C (–4°F to 140°F)		
Humidity	0–90% relative humidity		non-condensing
Weight	approx. 340 g (12 oz)		incl. packing and scope of supply
EMC compatibility	interference immunity in acc. with: EN 61000-6-1, EN 61000-6-2 emitted interference in acc. with: EN 61000-6-3, EN 61000-6-4		CE in accordance with EMC directive 89/336 EEC

## Contact

**Bircher Reglomat AG**  
Wiesengasse 20  
CH - 8222 Beringen  
Switzerland  
Phone +41 52 687 11 11  
Fax +41 52 687 11 12  
info@bircher.com  
www.bircher-reglomat.com

## Warranty and Liability

- The warranty and liability of Bircher Reglomat AG are based on the sales contract.
- The warranty and liability shall expire prematurely, should the client or third parties not use and/or operate the product in compliance with existing operating instructions, should incorrect changes or repairs be made by the client or third parties, should the client or third parties, when a fault has occurred, not take suitable steps at once for a reduction of possible damage/losses and offer Bircher Reglomat AG a chance for remedying the said fault.
- The warranty and liability shall exclude any damage for which there is no proof that it is due to poor materials, faulty construction, poor workmanship, and any

damage caused by other reasons, for which Bircher Reglomat AG cannot be held liable.

- No liability can be assumed for any consequential damage, provided this is not governed otherwise by applicable product liability laws and regulations.
- Warranty claims made against the seller on the basis of the sales agreement are not affected by these regulations.
- For the benefit of its customers Bircher Reglomat AG constantly develops its products further. Bircher Reglomat AG reserves the right to make changes to any of the products described in this document without prior notice.